

PB 01006300174



**PRESA DI FORZA A COMANDO
PNEUMATICO**

"POWER-TRUCK"

PNEUMATIC CLUTCH POWER TAKE-OFF

CODICE PTO
PTO CODE

10-61/62/63

CAMBIO
GEARBOX

**ZF-ECOSPLIT
EATON
MERCEDES
VOLVO**



DIAGRAMMA DI UTILIZZO
WORKING CONDITION

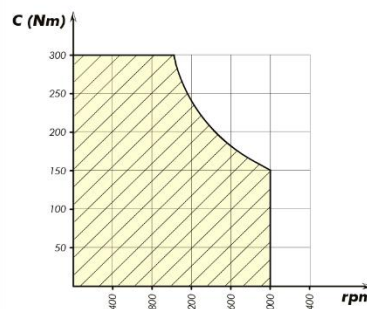

010-061-00176

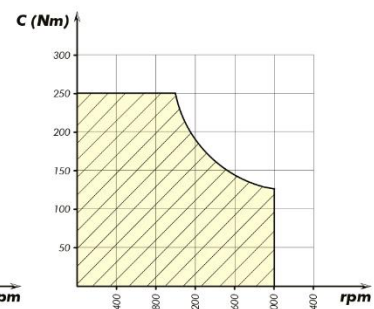

010-062-00175
010-063-00174

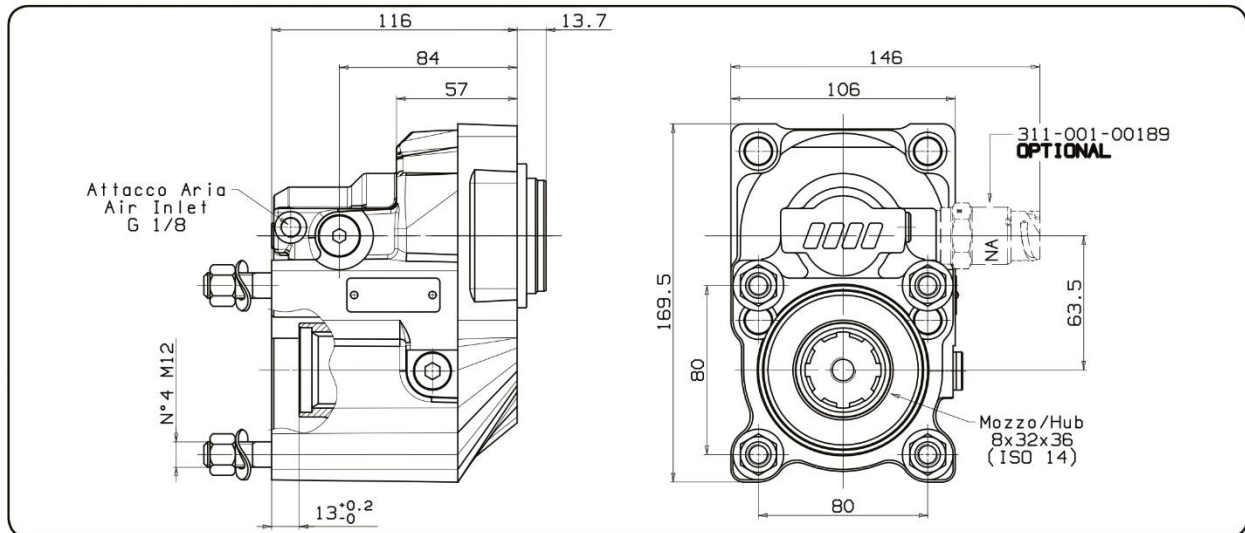

Tipo cambio Gearbox	Codice PTO PTO code	Versione Version	Rapporto interno Internal ratio	Giri pto a 1000 giri motore Pto ratio@1000 eng.rpm rpm	Coppia massima Max torque Nm	Lato montaggio Mounting side	Uscita Output	Rotazione Rotation	Kit di montaggio Mounting kit	Peso Weight Kg
ZF ECOSPLIT EATON MERCEDES VOLVO	10-61-176	17	1:1,81	Vedi indice See index	300	Poster. Rear	Poster. Rear	Ant. Acw	Vedi indice See index	8
	10-62-175		1:1,53							
	10-63-174		1:1,31		250					