

EV SAP 034 DIN

- → = Part
- ● = Kit

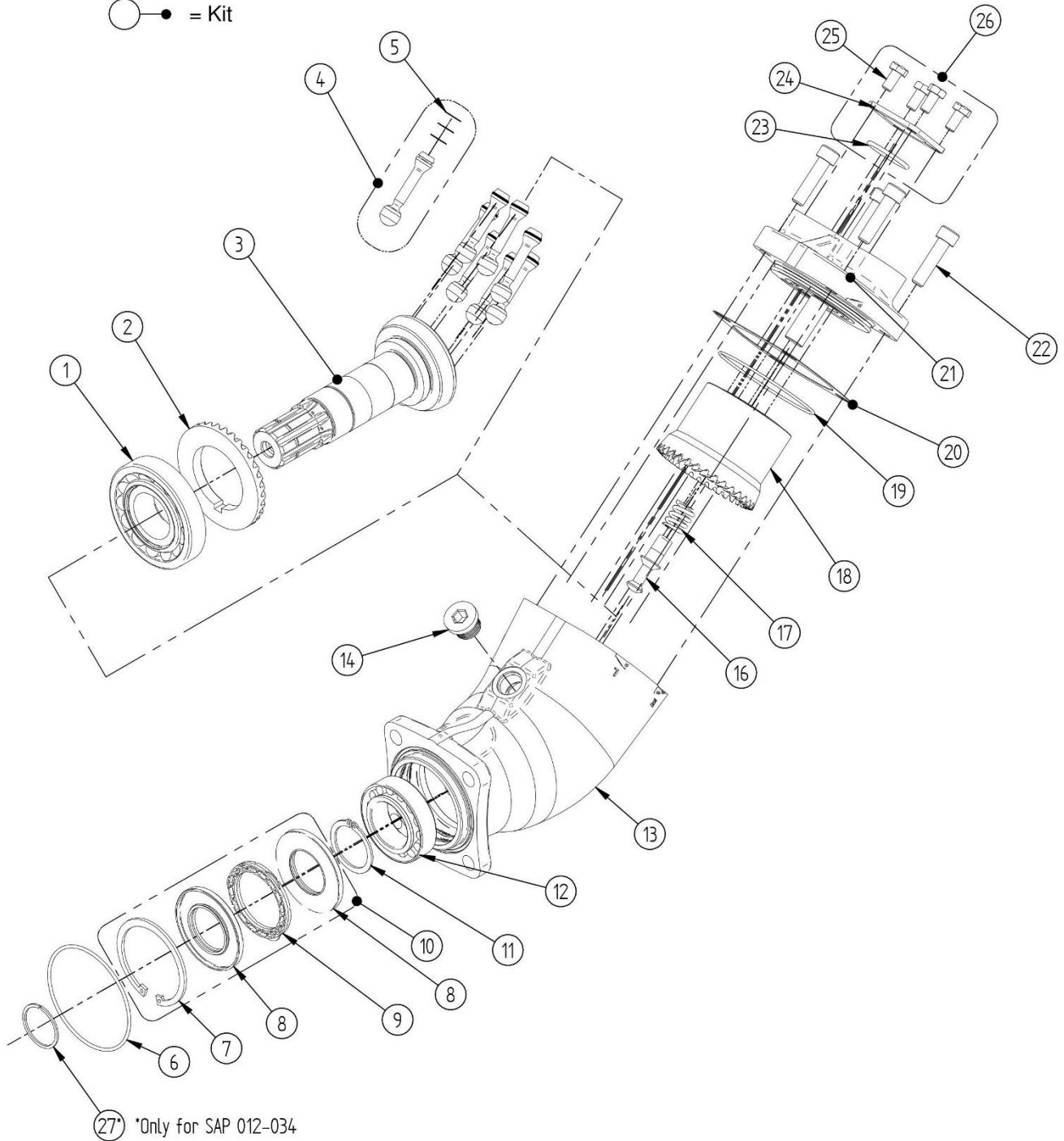

SAP 034

Item	Title	Type*	Qty.
1	Tapered roller bearing		1
2	Gear ring		1
3	Shaft	L35	1
4	Piston (with piston rings)		7
5	Piston rings		21
6	O-ring		1
7	Lock ring		1
8	Shaft seal		2
9	Sealing support		1
10	Shaft seal kit		-
11	Lock ring		1
12	Tapered roller bearing		1
13	Pump housing	DL4-DIN 4-hole	1
14	Plug		1
16	Spring pin		1
17	Spring		1
18	Cylinder block		1
19	O-ring		1
20	Shim		1
21	Connection Cover	S0S-0	1
21	Connection Cover (Left)	S0S-2	1
21	Connection Cover (Right)	S0S-2	1
22	Bolt		4
23	O-ring		1
24	Clamping plate		2
25	Bolt		4
26	Clamping plate kit		-
27	Lock ring		1
-	Seal Kit Includes Items 6, 7, 8, 9, 14, 19, 20, 23		-